

# Designing Collaborative Systems of Systems in support of Multi-sided Markets

Philip Boxer, Software Engineering Institute

Dr Nicholas J. Whittall, Thales UK Aerospace

12th NDIA Annual Systems Engineering Conference, 28th  
October 2009

# Working within Ultra-Large-Scale (Eco)Systems\*:

*Analysis needs to be done across different scales*

## 'Large-scale' Analysis

'multi-sided' analysis of the deployed force relationship to demand

Establishing economics of alternative ways of delivering force cohesion 'at the edge'  
(e.g. through the use of Tactical UAVs)

## 'Medium-scale' Analysis

fitting together multiple stakeholders' perspectives on how particular systems of systems support missions

Identifying the interoperability risks across multiple parts of the SoS  
(e.g. AWACS modernisation)

## 'Small-scale' Analysis

establishing operational performance of software-reliant systems and sensors

Analyzing end-to-end asynchronous sensor and data fusion processes  
(e.g. Multi-Sensor Integration)

*The challenge is sustaining operational alignment across the different scales*

\* Containing large numbers of managerially and operationally independent systems

# Outline

1. Engineering in support of an operational space: the need for agility
2. Engineering for a multi-sided market: the need for two kinds of value
3. Engineering two kinds of value: creating value for defense

# Engineering in support of an operational space: the need for agility

Defining the relationship between the design space for an operational capability and the operational space within which it will be used

# Defining the Operational Space for Tactical UAV:

## The Watchkeeper CONOPS

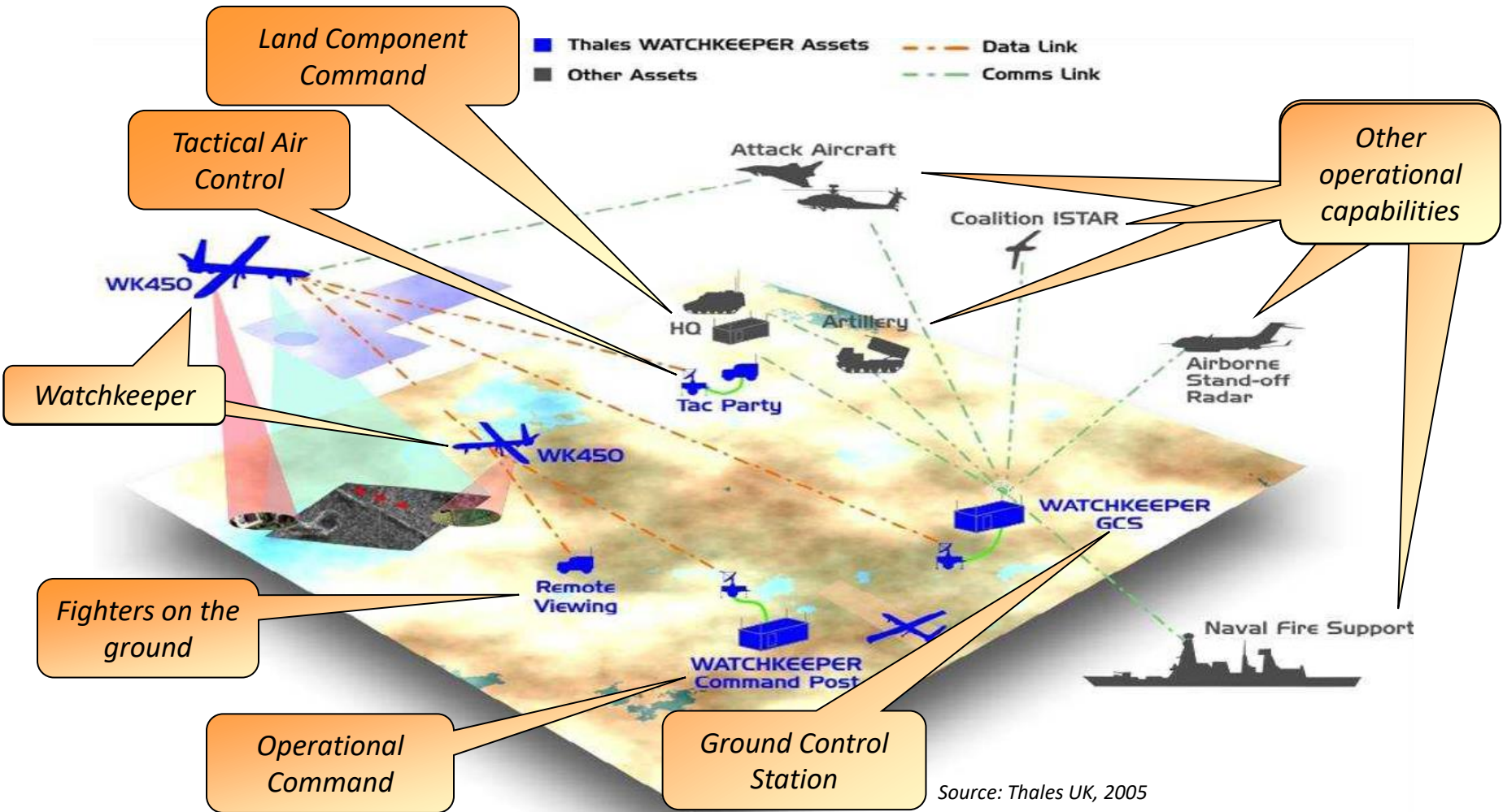

Source: Thales UK, 2005

# The evolving definition of an Operational Capability: The example of Tactical UAV

Phoenix and Watchkeeper UAVs were conceived as extensions to existing concepts of operation:

- Phoenix (TUAV 1) provided better target acquisition for Multiple Launch Rocket System (MLRS)
- Watchkeeper (TUAV II) provided better servicing of a Commander's Critical Information Requirements (CCIR)

For TUAVs I & II, the primary focus was on the required capabilities of the **system** in a *design space*.

# The evolving definition of an Operational Capability: The example of Tactical UAV

Phoenix and Watchkeeper UAVs were conceived as extensions to existing concepts of operation:

- Phoenix (TUAV 1) provided better target acquisition for Multiple Launch Rocket System (MLRS)
- Watchkeeper (TUAV II) provided better servicing of a Commander's Critical Information Requirements (CCIR)

For TUAVs I & II, the primary focus was on the required capabilities of the **system** in a *design space*.

The Urgent Operational Requirement (UOR) in Iraq and Afghanistan was for the close coupling of UAV capability to fighters on the ground reflected an increased campaign tempo, and the need for greater tactical agility (TUAV III

For TUAV III, the focus shifted to the **variety of demands** on the way the system could be used in the *operational space*.

# The demand for greater tactical agility: the example of mission situations involving the interdiction of fleeting targets

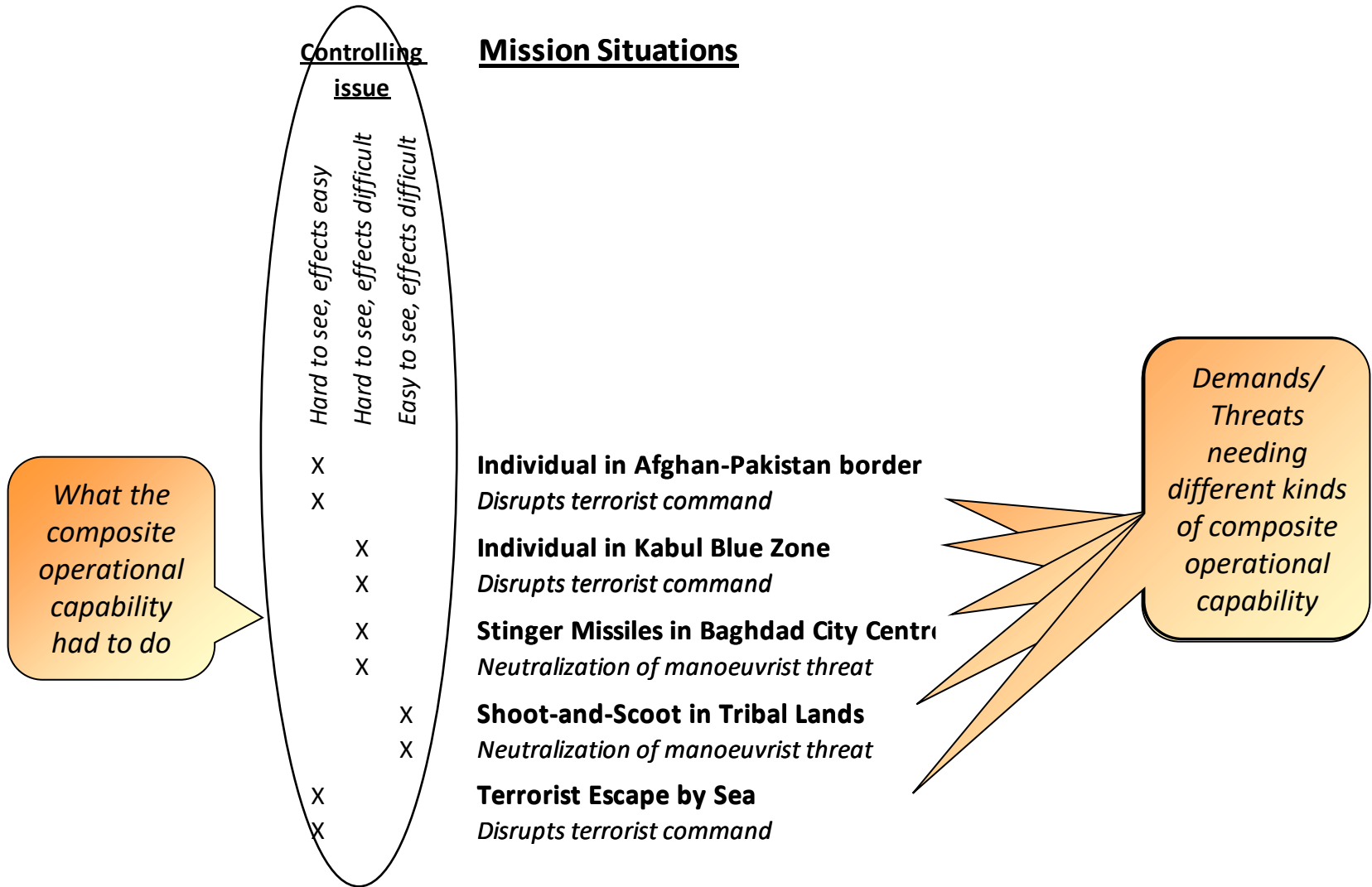



# The through-life costs of operational use

- The costs of the TUAV III Urgent Operational Requirement (UOR) were of the same order as the planned equipment costs.
- Could the demand for greater tactical agility have been anticipated?
- If so, how could its value have been established?

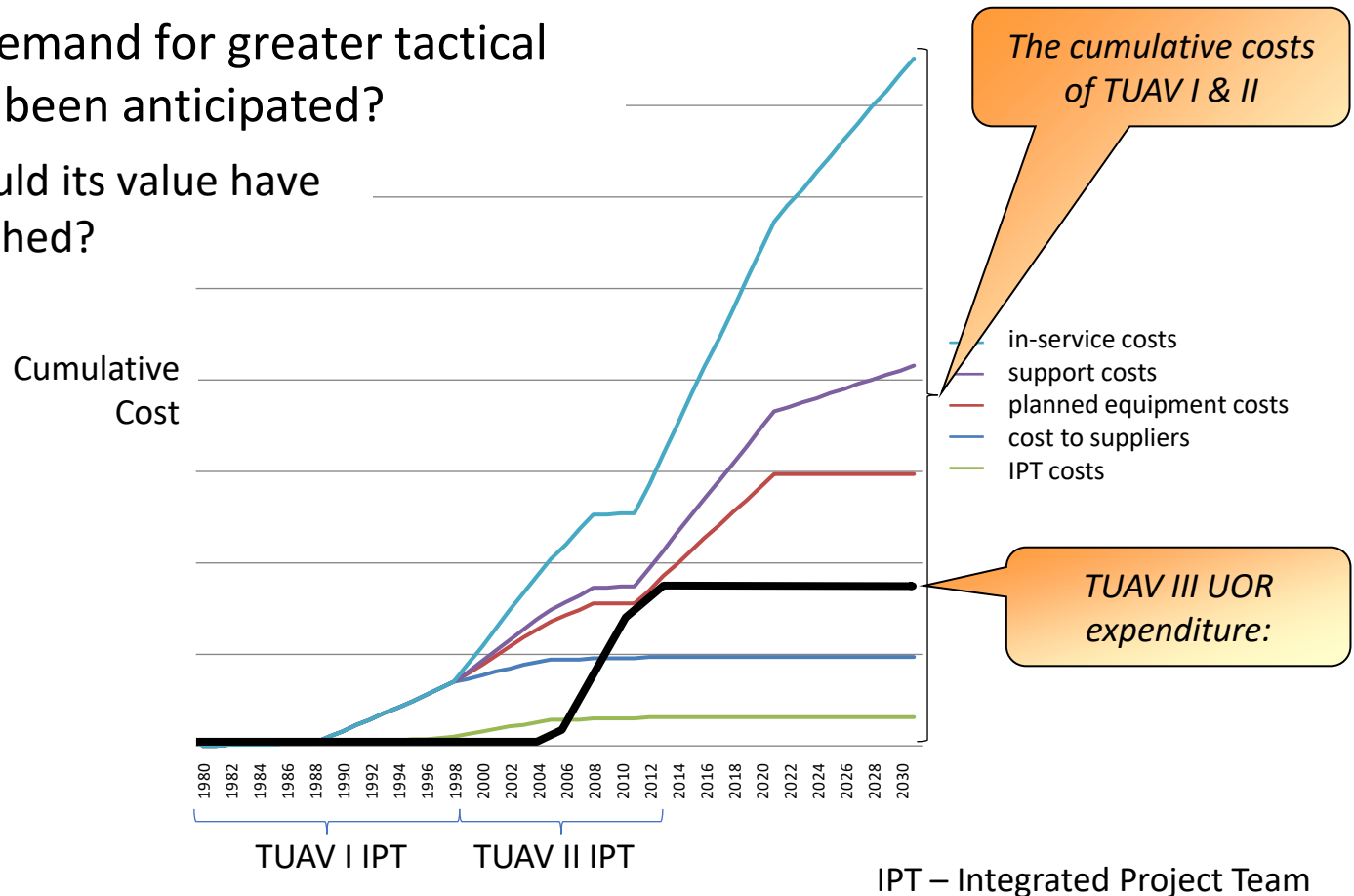

# The demand for Tactical Agility:

anticipating the effects of diverging tempos

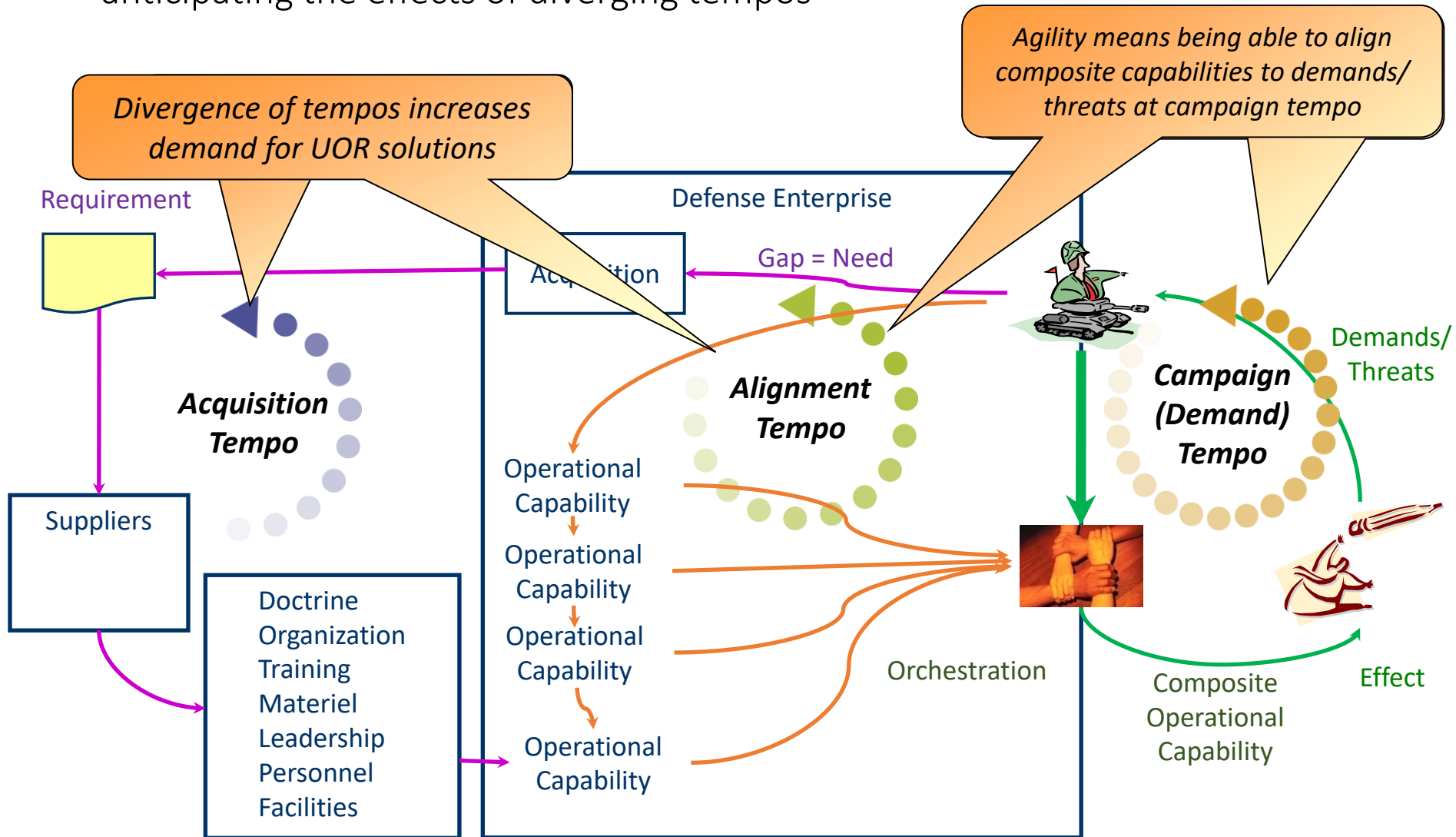

Adapted from: *Appropriate Collaboration and Appropriate Competition in C4ISTAR Transformation*, Dr Nicholas Whittall RUSI 2007

# Engineering in support of an Operational Space: the Composite Capability as a system-of-systems (SoS)

- The variety of mission situations needing support in the operational space far exceeded those anticipated in the design space. Hence the need for agility
  - For Tactical UAVs, the original customer intended for the operational capability was the Land Component Commander.
  - In practice, the uses of the operational capability formed part of multiple composite capabilities, each one a System of Systems
- The set of operational capabilities supporting these multiple forms of composite capability themselves formed a **Collaborative SoS**.
- How could the engineering of these composite capabilities be supported from within the capability design space?

# Engineering for a multi-sided market: the need for two kinds of value

Designing multi-sided platforms for an operational space defined as a multi-sided market

# Multi-sided markets:

counting the value of indirect market relationships

- A multi-sided market for a supplier is one in which:
  - There is value in its direct ‘one-sided’ relationships with each market participant
  - There is greater value in its indirect ‘multi-sided’ relationships with collaborating market participants
- There has to be more value for the market participant in using the supplier’s platform than not

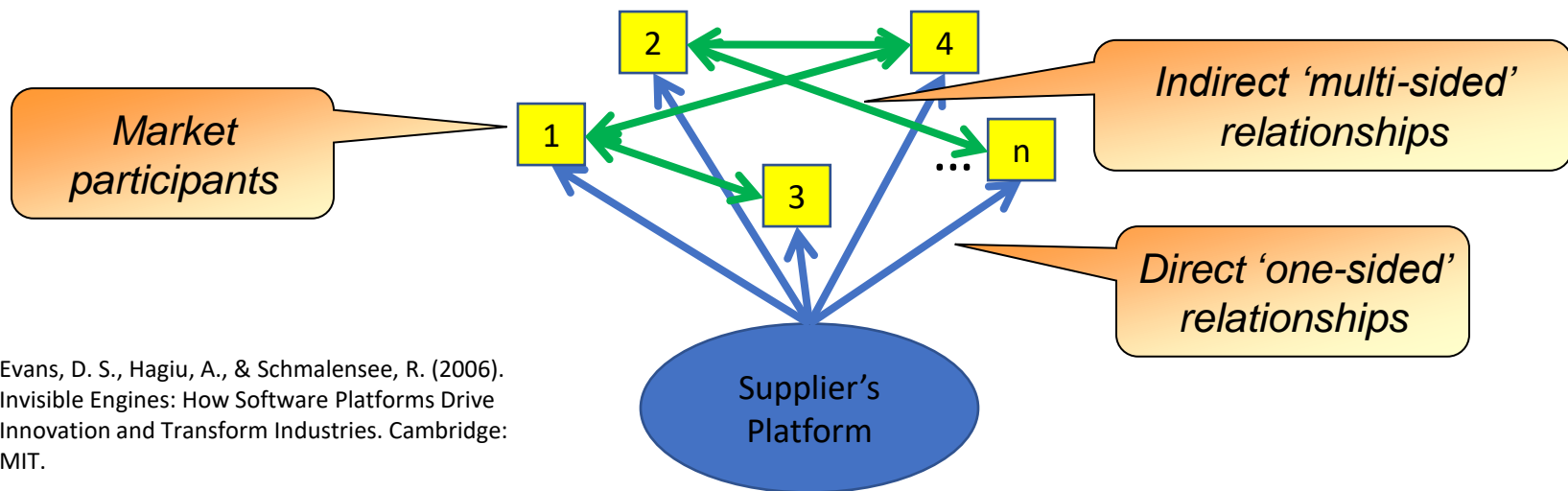

Evans, D. S., Hagiu, A., & Schmalensee, R. (2006). *Invisible Engines: How Software Platforms Drive Innovation and Transform Industries*. Cambridge: MIT.

# Multi-sided Platforms: the iPod Touch example

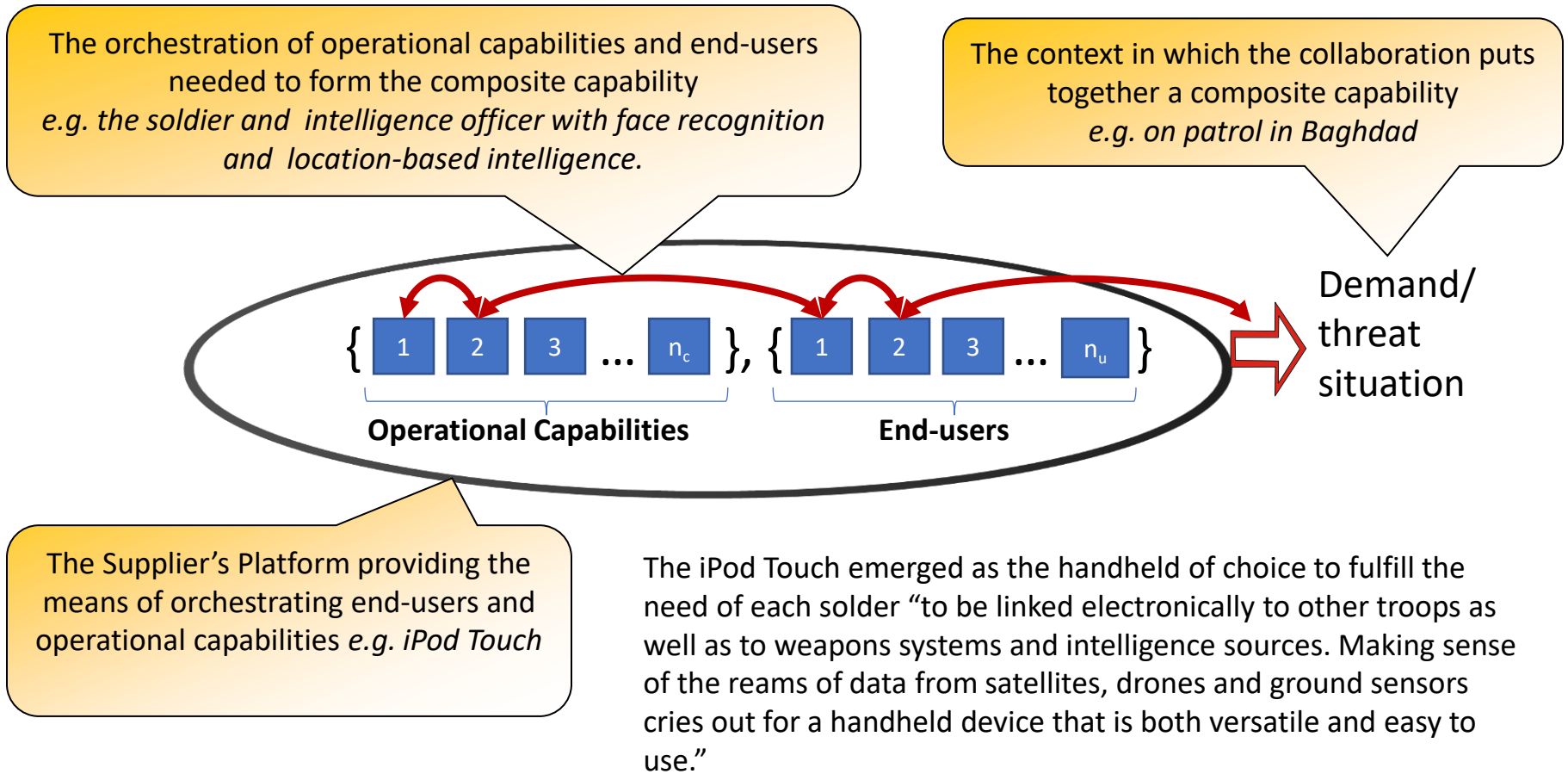

Source: Sutherland, B. (2009, April 27). Apple's New Weapon: To help soldiers make sense of data from drones, satellites and ground sensors, the U.S. military now issues the iPod Touch. Newsweek .

# Defining the Composite Capabilities:

the need for tactical agility

## Mission Situations

## Composite Capabilities

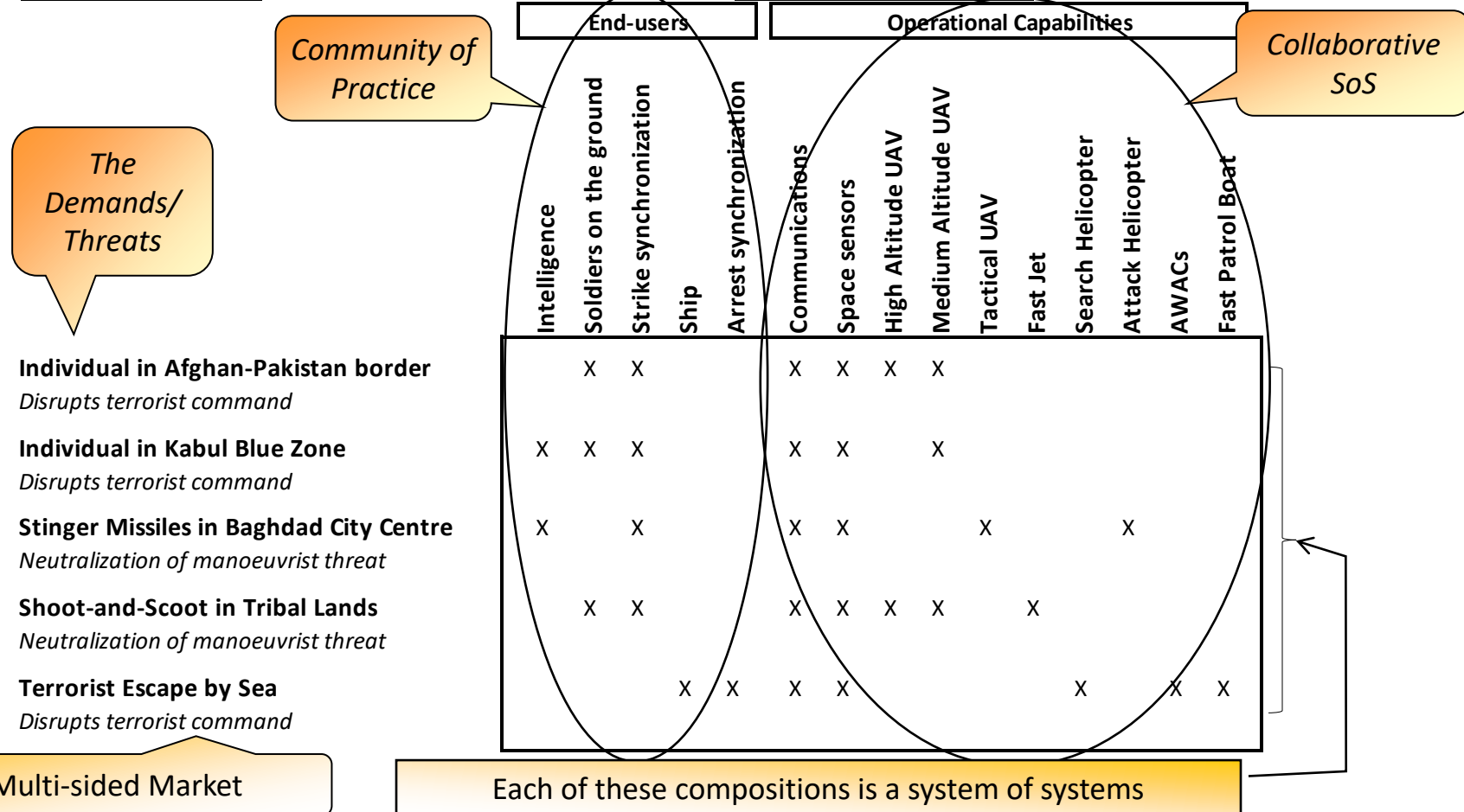

# Substituting a TUAV multi-sided platform: creating indirect benefits through greater flexibility

## Mission Situations

## Composite Capabilities

Indirect value through its impact on the way different collaborations can be formed

End-users		Operational Capabilities										
-----------	--	--------------------------	--	--	--	--	--	--	--	--	--	--

	Intelligence	Soldiers on the ground	Strike synchronization	Ship	Arrest synchronization	Communications	Space sensors	High Altitude UAV	Medium Altitude UAV	Tactical UAV	Fast Jet	Search Helicopter	Attack Helicopter	AWACs	Fast Patrol Boat
<b>Individual in Afghan-Pakistan border</b> <i>Disrupts terrorist command</i>	X	X				X	X	X	X						
<b>Individual in Kabul Blue Zone</b> <i>Disrupts terrorist command</i>	X	X	X			X	X		X						
<b>Stinger Missiles in Baghdad City Centre</b> <i>Neutralization of manoeuvrist threat</i>	X		X			X	X			X			X		
<b>Shoot-and-Scoot in Tribal Lands</b> <i>Neutralization of manoeuvrist threat</i>		X	X			X	X	X	X		X				
<b>Terrorist Escape by Sea</b> <i>Disrupts terrorist command</i>				X	X	X	X					X		X	X

Direct value through substitution

The Multi-sided platform



# Engineering for a multi-sided market

- The multi-sidedness of the operational space (the multi-sided market) defines the need for a supporting Collaborative SoS
- Engineering a platform for a multi-sided market involves creating two kinds of benefit:
  - The direct benefit the platform provides to each of its users
  - The indirect benefit it provides by supporting collaboration between end-users and operational capabilities to form composite capabilities
- The flexibility of a multi-sided platform in support of indirect benefits increases the agility of the force structure in which it participates

# Engineering two kinds of value: creating value for defense

Value for Defense is maximized when agility is delivered at minimum cost

# Defining Value for Defense:

analyzing the layers of alignment across the different scales

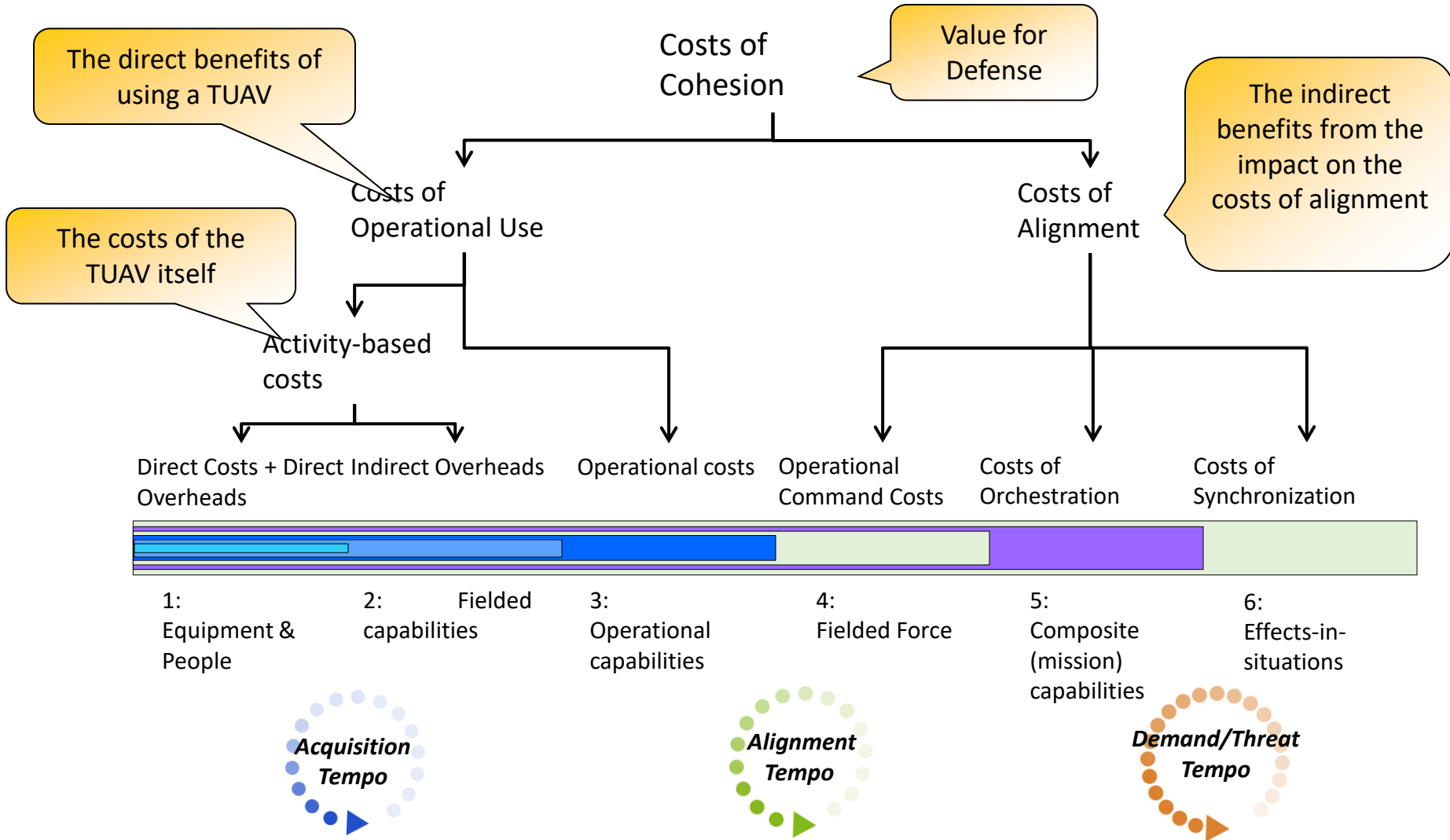

# Cohesion-based Costing: analyzing the cohesion costs of composite (mission) capabilities

*Modeling the variety of composite capabilities*

*Analyzing the different layers of alignment*

*Analyzing cohesion costs*

## Modeling Alignment Processes

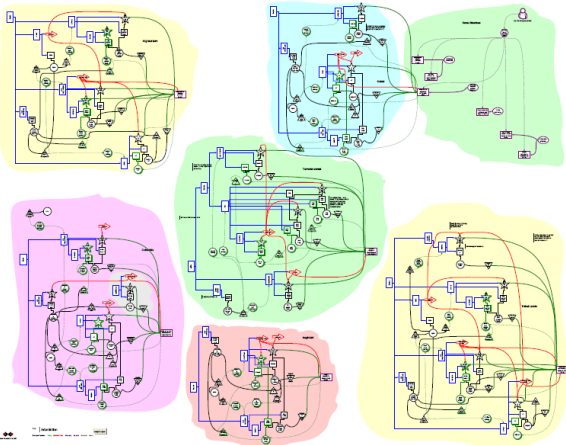

## Analyzing alignment to demand

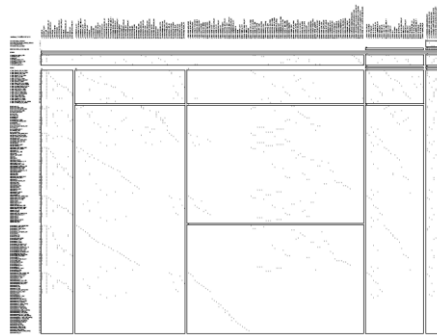

## Costing Cohesion of Composite Capabilities

Scenario	orch\afghan_border_strike	outcome\border_hale_on_station	outcome\border_male_strike	outcome\border_of_on_station	know\border_of	know\border_male_strike	know\border_hale_global_hawk	design\border_male_operator	capv\border_hale_global_hawk	capv\border_male_reaper	system\border_hale_global_hawk	system\border_of	process\border_hale_global_hawk	process\border_of	dprocess\border_hale_global_hawk	dprocess\border_male_reaper
1	1	1	1	1	1	1	1	1	1	1	1	1	1	1	1	1
2	1	1	1	1	1	1	1	1	1	1	1	1	1	1	1	1
3	1	1	1	1	1	1	1	1	1	1	1	1	1	1	1	1
4	1	1	1	1	1	1	1	1	1	1	1	1	1	1	1	1
5	1	1	1	1	1	1	1	1	1	1	1	1	1	1	1	1
6	1	1	1	1	1	1	1	1	1	1	1	1	1	1	1	1
7	1	1	1	1	1	1	1	1	1	1	1	1	1	1	1	1
8	1	1	1	1	1	1	1	1	1	1	1	1	1	1	1	1
9	1	1	1	1	1	1	1	1	1	1	1	1	1	1	1	1
10	1	1	1	1	1	1	1	1	1	1	1	1	1	1	1	1
11	1	1	1	1	1	1	1	1	1	1	1	1	1	1	1	1
12	1	1	1	1	1	1	1	1	1	1	1	1	1	1	1	1
13	1	1	1	1	1	1	1	1	1	1	1	1	1	1	1	1
14	1	1	1	1	1	1	1	1	1	1	1	1	1	1	1	1
15	1	1	1	1	1	1	1	1	1	1	1	1	1	1	1	1
16	1	1	1	1	1	1	1	1	1	1	1	1	1	1	1	1
17	1	1	1	1	1	1	1	1	1	1	1	1	1	1	1	1
18	1	1	1	1	1	1	1	1	1	1	1	1	1	1	1	1
19	1	1	1	1	1	1	1	1	1	1	1	1	1	1	1	1
20	1	1	1	1	1	1	1	1	1	1	1	1	1	1	1	1
21	1	1	1	1	1	1	1	1	1	1	1	1	1	1	1	1
22	1	1	1	1	1	1	1	1	1	1	1	1	1	1	1	1
23	1	1	1	1	1	1	1	1	1	1	1	1	1	1	1	1
24	1	1	1	1	1	1	1	1	1	1	1	1	1	1	1	1
25	1	1	1	1	1	1	1	1	1	1	1	1	1	1	1	1
26	1	1	1	1	1	1	1	1	1	1	1	1	1	1	1	1
27	1	1	1	1	1	1	1	1	1	1	1	1	1	1	1	1
28	1	1	1	1	1	1	1	1	1	1	1	1	1	1	1	1
29	1	1	1	1	1	1	1	1	1	1	1	1	1	1	1	1
30	1	1	1	1	1	1	1	1	1	1	1	1	1	1	1	1
31	1	1	1	1	1	1	1	1	1	1	1	1	1	1	1	1
32	1	1	1	1	1	1	1	1	1	1	1	1	1	1	1	1
33	1	1	1	1	1	1	1	1	1	1	1	1	1	1	1	1
34	1	1	1	1	1	1	1	1	1	1	1	1	1	1	1	1
35	1	1	1	1	1	1	1	1	1	1	1	1	1	1	1	1
36	1	1	1	1	1	1	1	1	1	1	1	1	1	1	1	1
37	1	1	1	1	1	1	1	1	1	1	1	1	1	1	1	1
38	1	1	1	1	1	1	1	1	1	1	1	1	1	1	1	1
39	1	1	1	1	1	1	1	1	1	1	1	1	1	1	1	1
40	1	1	1	1	1	1	1	1	1	1	1	1	1	1	1	1
41	1	1	1	1	1	1	1	1	1	1	1	1	1	1	1	1
42	1	1	1	1	1	1	1	1	1	1	1	1	1	1	1	1
43	1	1	1	1	1	1	1	1	1	1	1	1	1	1	1	1
44	1	1	1	1	1	1	1	1	1	1	1	1	1	1	1	1
45	1	1	1	1	1	1	1	1	1	1	1	1	1	1	1	1
46	1	1	1	1	1	1	1	1	1	1	1	1	1	1	1	1
47	1	1	1	1	1	1	1	1	1	1	1	1	1	1	1	1
48	1	1	1	1	1	1	1	1	1	1	1	1	1	1	1	1
49	1	1	1	1	1	1	1	1	1	1	1	1	1	1	1	1
50	1	1	1	1	1	1	1	1	1	1	1	1	1	1	1	1

## The ability to analyze cohesion costs offers:

- The cohesion costs of any particular situation in a campaign
- The range of cohesion costs across a variety of situations arising in different types of campaign

# Pricing Agility: *valuing the impact of greater TUAV flexibility*

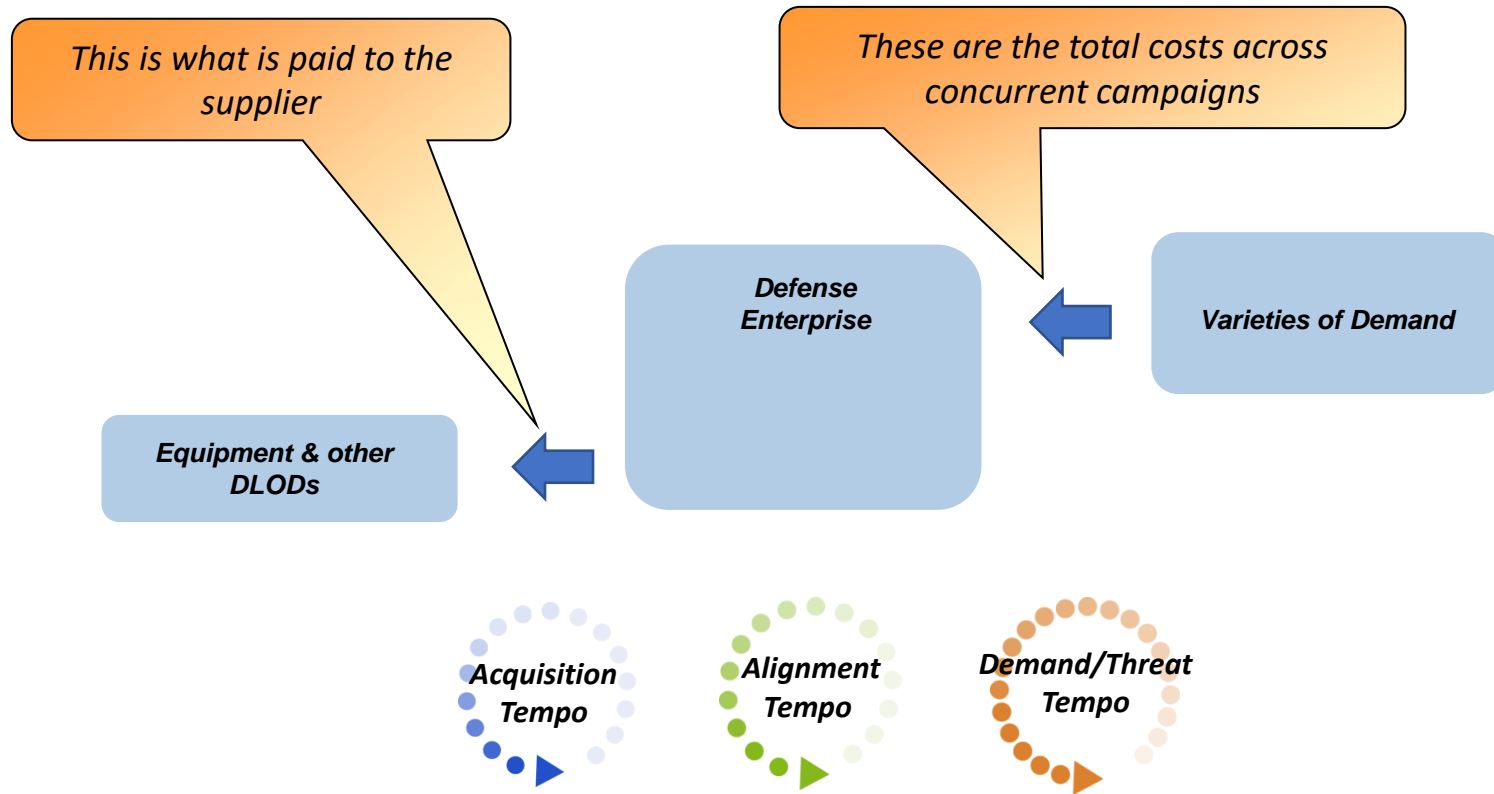

# Pricing Agility: *valuing the impact of greater TUAV flexibility*

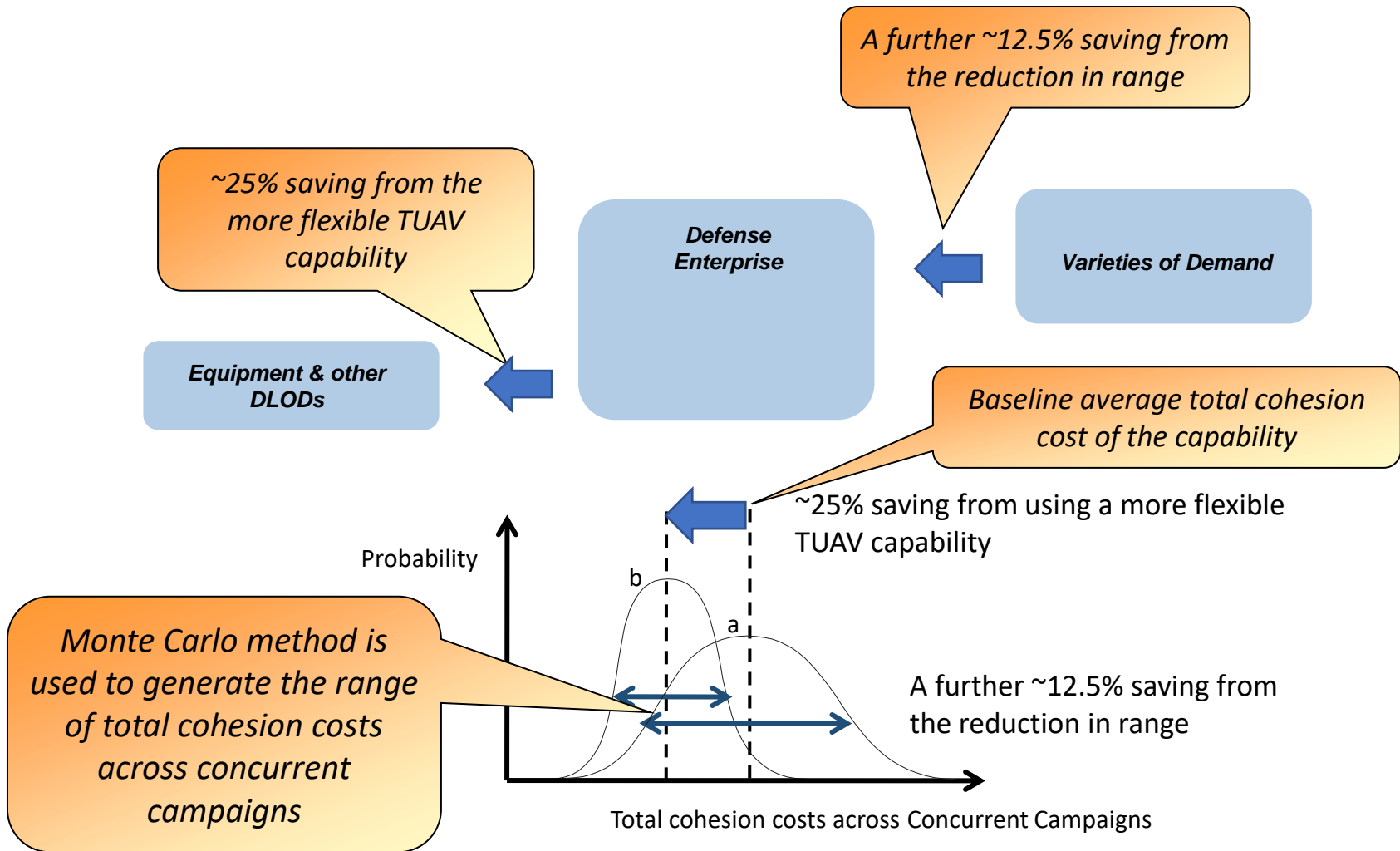

# Distinguishing two kinds of value:

*Determining the maximum price of Value for Defense*

The analysis of total cohesion costs for Concurrent Campaigns delivers:

- A baseline range of costs of supporting this variety of situations
- A lower average cost and a narrower range of costs of delivering this same variety with more flexible TUAV capability

The maximum price of Value for Defense should reflect two kinds of value:

- The direct benefit of greater capability in the platform itself, and
- The indirect benefit of greater force agility arising from the flexibility of the platform

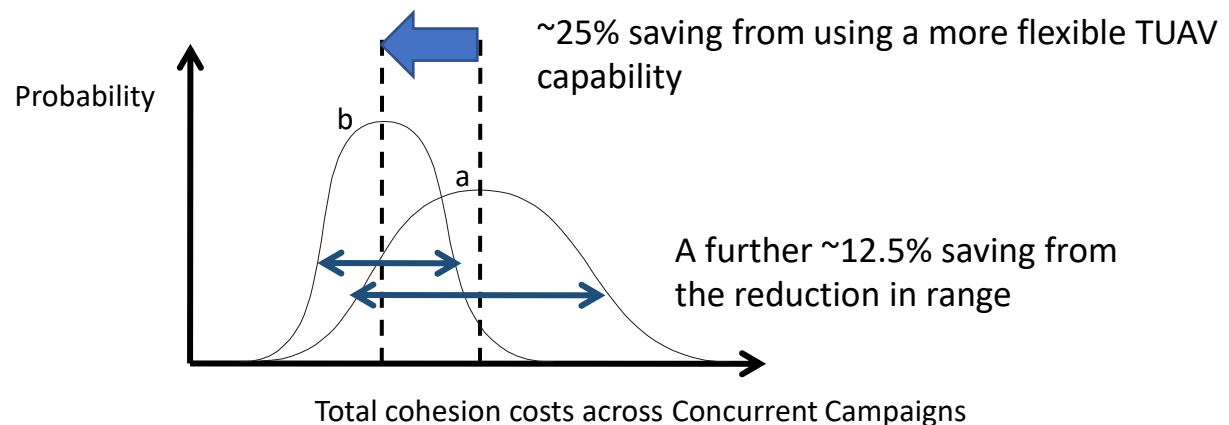

# Conclusion

- The need for agility creates new challenges for engineering in support of an operational space.

*This involves understanding the impact on the design space of variety of use in the operational capability space.*

- This variety of use can be approached in terms of the multi-sidedness of the market into which capabilities are being deployed

*This leads to designing platforms for multi-sided use within an operational space.*

- Creating value for defense therefore involves an engineering approach that can generate indirect as well as direct benefits

*Such engineering depends on being able to define both kinds of Value for Defense.*